

# TELEPHONE JACK WITH MAGNETICS

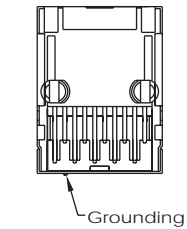

MODULAR TELEPHONE JACK UL / CSA / FCC APPROVED

## TYPE S SINGLE PORT SHIELDED MAGNETIC PHONE JACK

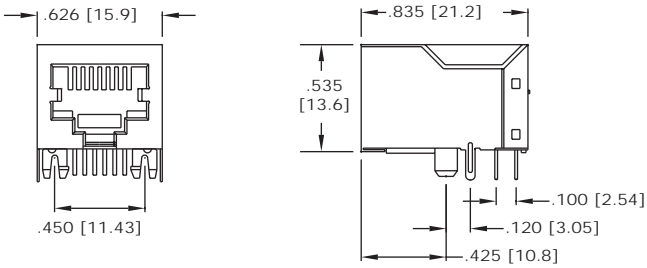

T-SX-8P8C-3-F

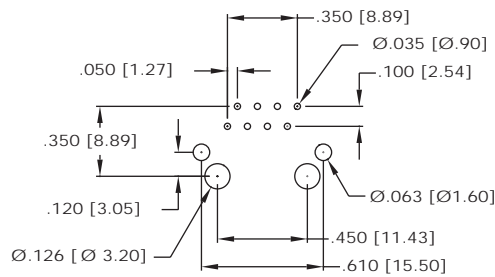

PC Board Layout

Specification :

Item	Parameter	Condition	Min.	Typ.	Max.	Unit	REMARK
1	Insertion loss	1-100 MHz			-1	dB	
		1-30 MHz	-16			dB	
		30-60 MHz				dB	NOTE 1
2	Return loss	60-80 MHz	-10			dB	
		100 KHz-100 MHz	-35			dB	
3	Comm. To Diff. Rejection	100 KHz-100 MHz	-35			dB	
4	Comm. To Comm. Rejection	100 KHz-100 MHz	-35			dB	
5	OCL	100 KHz	350			mH	
6	Crosstalk	100 KHz-100 MHz	-35			dB	
7	Hipot	Vrms	1.5			kV	
8	Turns Ratio (Chip : Cable)	TX: 1 : 1 RX: 1 : 1				CT	
9	Direct Current resistance					Ω	

\* NOTE 1: Greater than (16-20 Log (f/30MHz)) dB

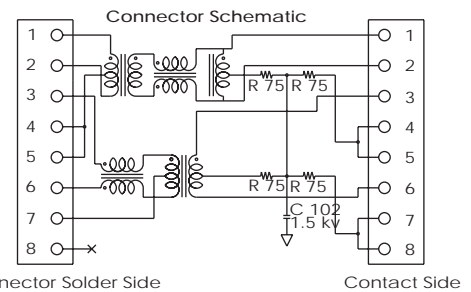

Connector Solder Side

Contact Side

## TYPE T MULTI PORT SHIELDED MAGNETIC PHONE JACK

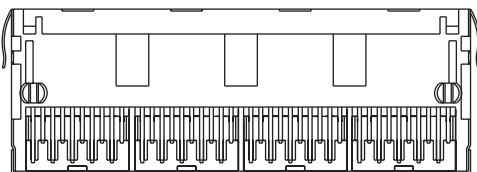
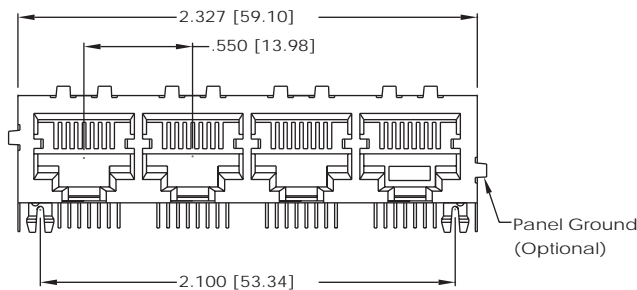

TG4-TX-8P8C-3-F

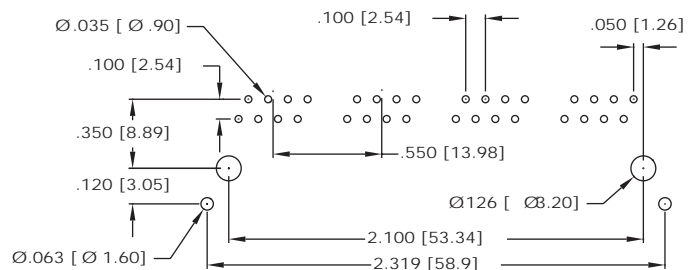
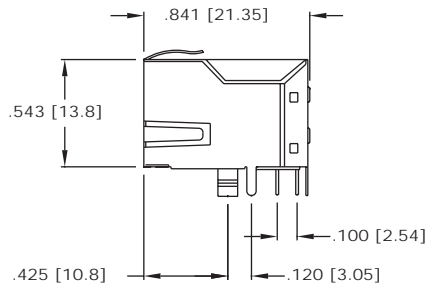

PC Board Layout

# TELEPHONE JACK WITH MAGNETICS

MODULAR TELEPHONE JACK UL / CSA / FCC APPROVED

## TYPE U SINGLE PORT SHIELDED MAGNETIC PHONE JACK

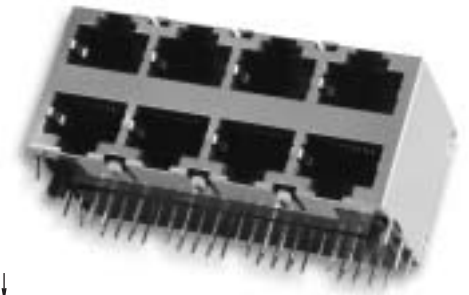
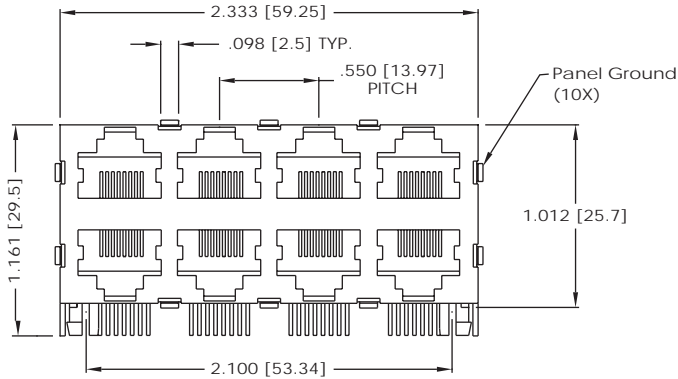

TG8-U-8P8C-3-F

### PC Board Layout

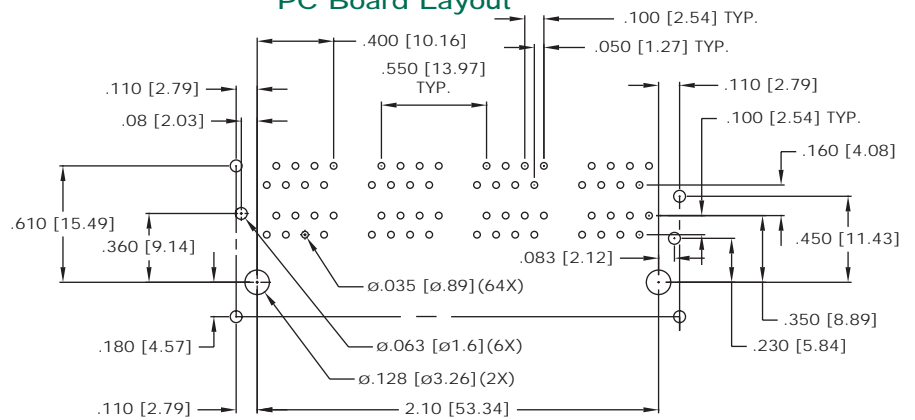
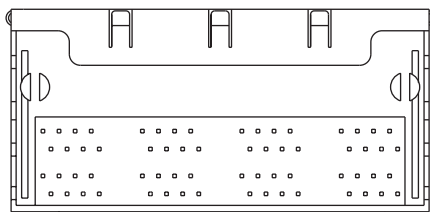

## TYPE V MAGNETIC PHONE JACK OVER DUAL USB WITH LED'S

TU-V-8P8C-3-F

