

# COMPACT PCI

2.00mm CENTERLINE



## SPECIFICATIONS

### Material:

**Insulator:** PBT, glass reinforced thermoplastic, rated UL 94V-0  
**Contacts:** Phosphor Bronze

### Plating:

5 µin gold over 50 µin nickel underplate on contact area and 100 µin tin-lead on solder-tails

### Electrical:

**Operation voltage:** 500 VAC max  
**Current rating:** 1 Amp max  
**Contact resistance:** 20 mΩ max  
**Insulation resistance:** 1000 MΩ min @ 1000 VDC between adjacent contacts (75°F and 50% R.H.)  
**Dielectric withstanding voltage:** 1000 VDC min rms (sea level)

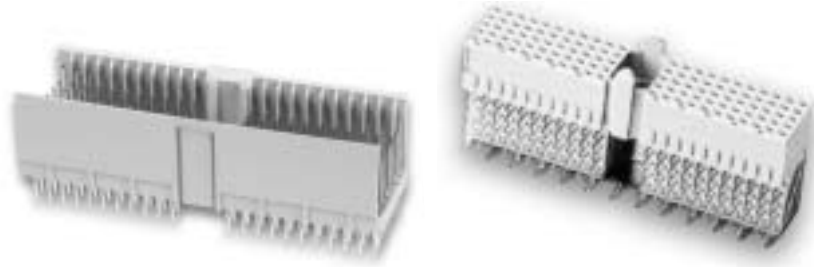

## ORDERING INFORMATION

choose one from each category as shown in sample below

2CP	HV	A	95	09	Options
Series	Body Type	Type	No. Of Contacts	Mating / Tail Length	
2CP - 2mm Compact PCI	HV - Header Vertical SR - Socket Right Angle	A, B19, B22, B25, C, AB19, AB22, AB25	55, 95, 110, 125, 77, 154, 133, 175	01 - 8.2/3.7 02 - 9.7/3.7 03 - 11.2/3.7 04 - 8.2/4.5 05 - 9.7/4.5 06 - 11.2/4.5 07 - 8.2/13.0 08 - 9.7/13.0 09 - 11.2/13.0 10 - 8.2/14.5 11 - 9.7/14.5 12 - 11.2/14.5 13 - 8.2/16.0 14 - 9.7/16.0 15 - 8.2/13.0 16 - 11.1/16.0	15 - 15 µin gold plating on contact area 30 - 30 µin gold plating on contact area

## PIN LENGTH DESIGNATOR CHARTS

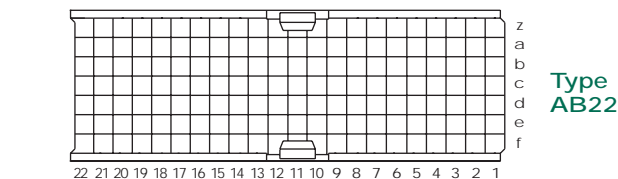
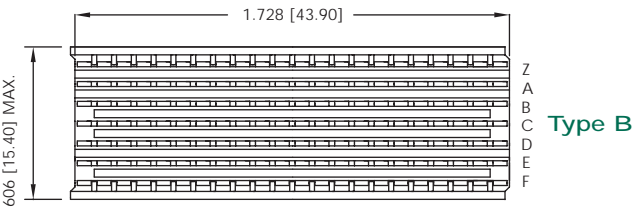
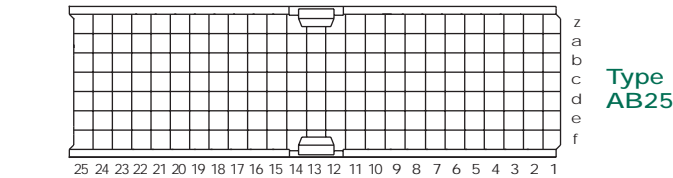
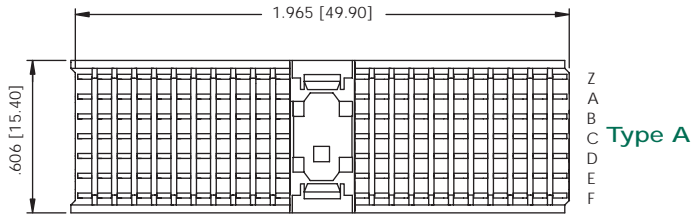

Charts for Customer Use to Designate Pin Lengths

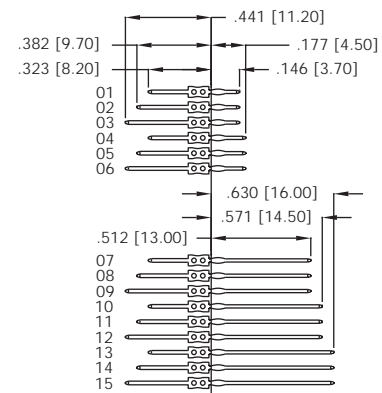

SEATING PLANE FOR CONNECTOR

CONTACT DIMENSIONS

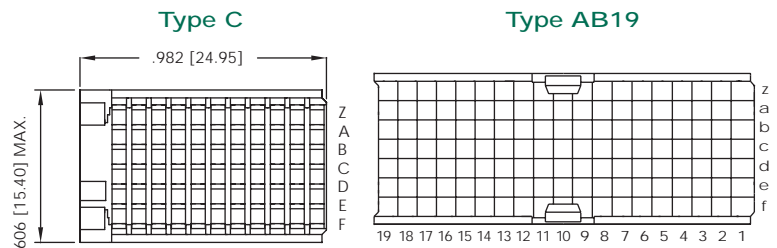

# COMPACT PCI

2.00mm CENTERLINE

## 2CP - HV - A - 154

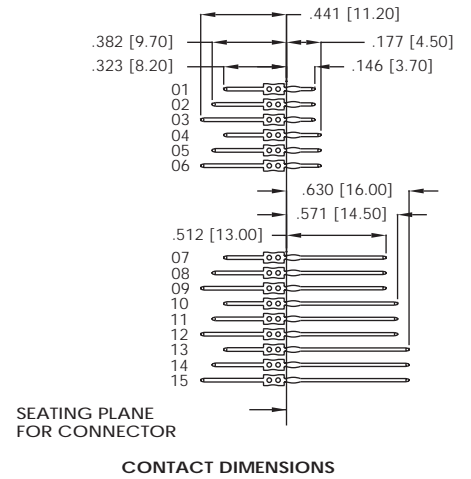
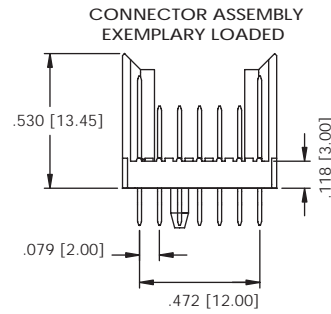
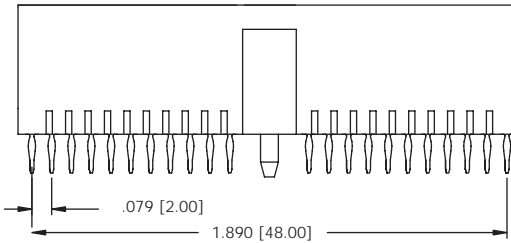
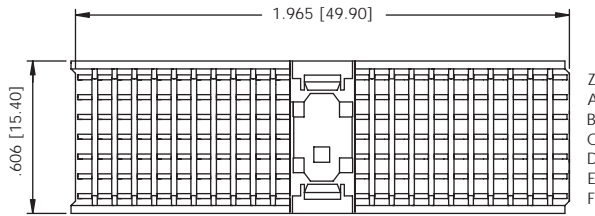

## 2CP - HV - C - 77

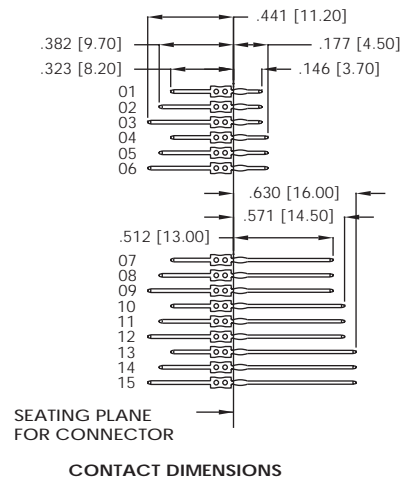
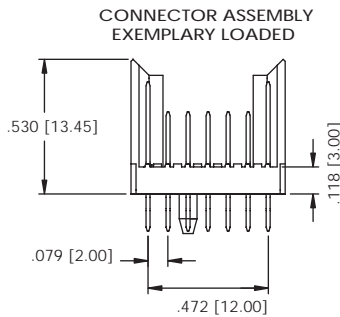
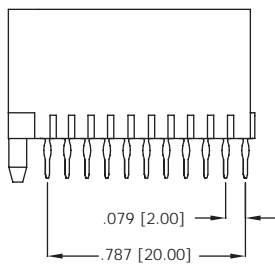
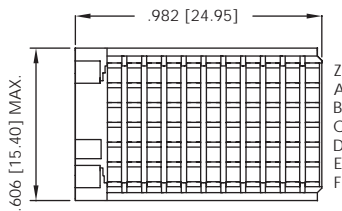

## 2CP - HV - B22 - 154

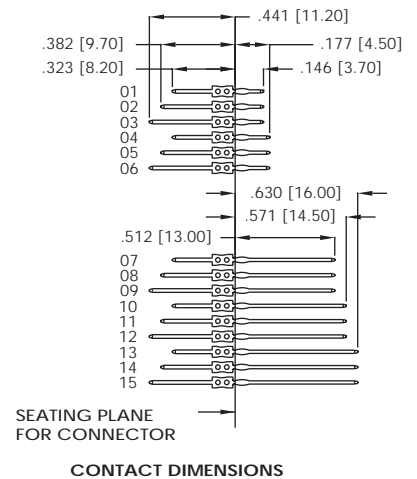
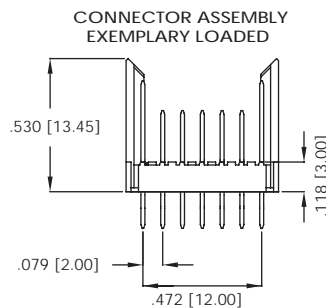
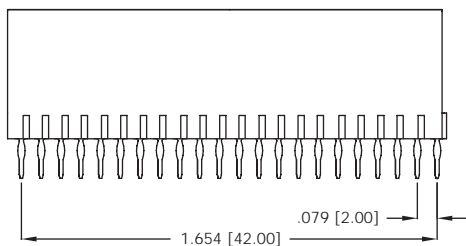
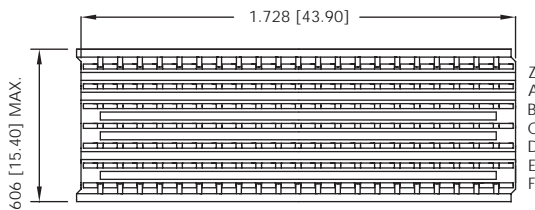

# COMPACT PCI

2.00mm CENTERLINE

## 2CP - HV - AB19 - 133

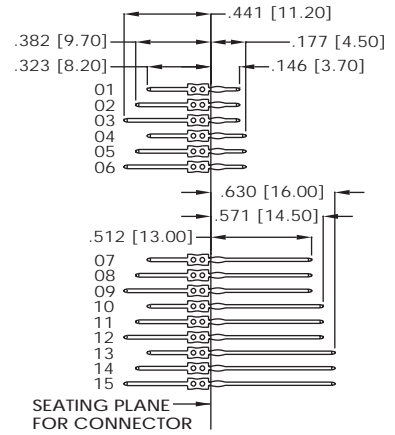
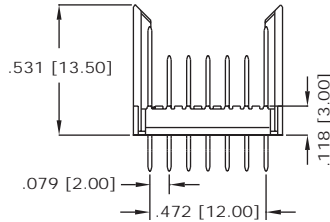
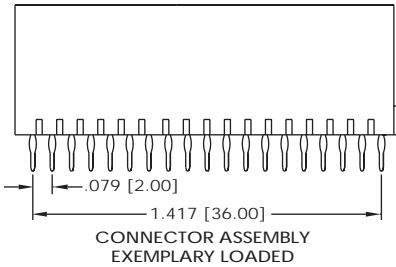
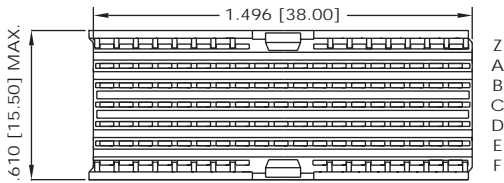

CONTACT DIMENSIONS

## 2CP - HV - AB22 - 154

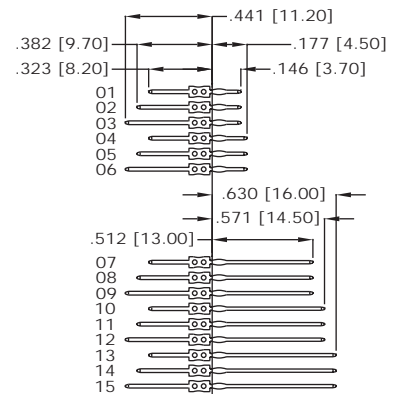
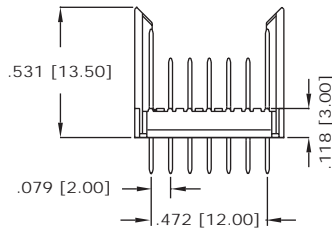
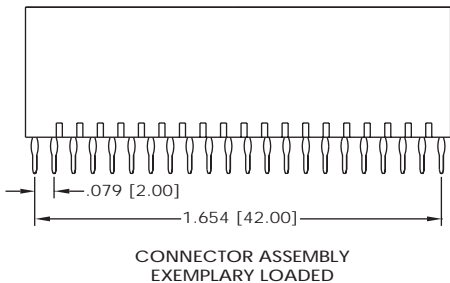
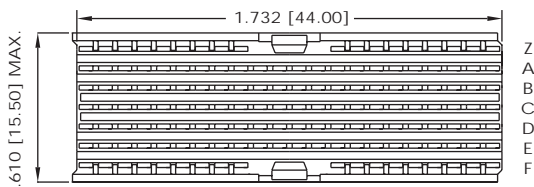

CONTACT DIMENSIONS

## 2CP - HV - AB25 - 175

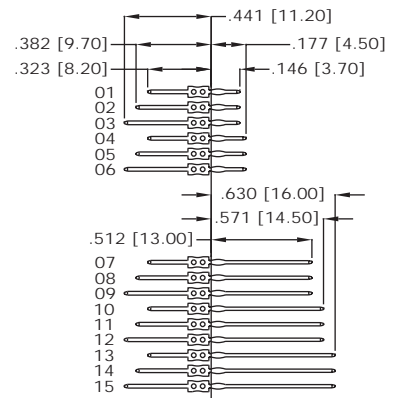
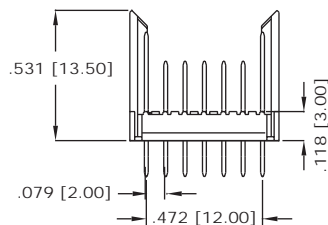
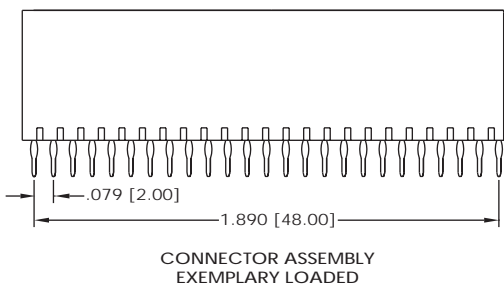
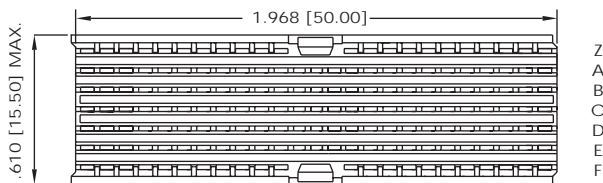

CONTACT DIMENSIONS

# COMPACT PCI

2.00mm CENTERLINE

## 2CP - SR - B25 - 125

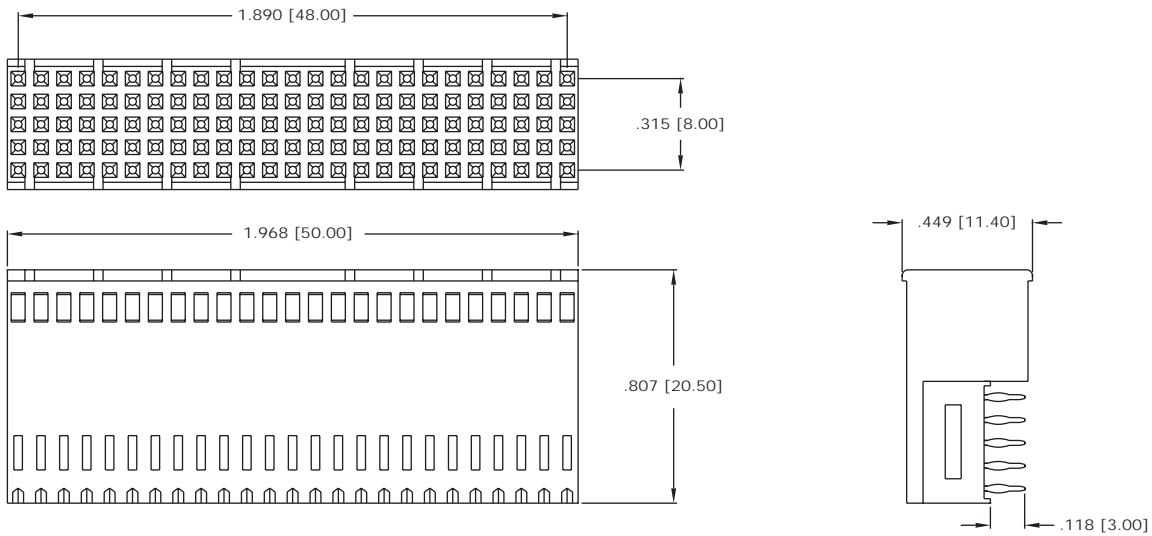

## 2CP - SR - A - 110

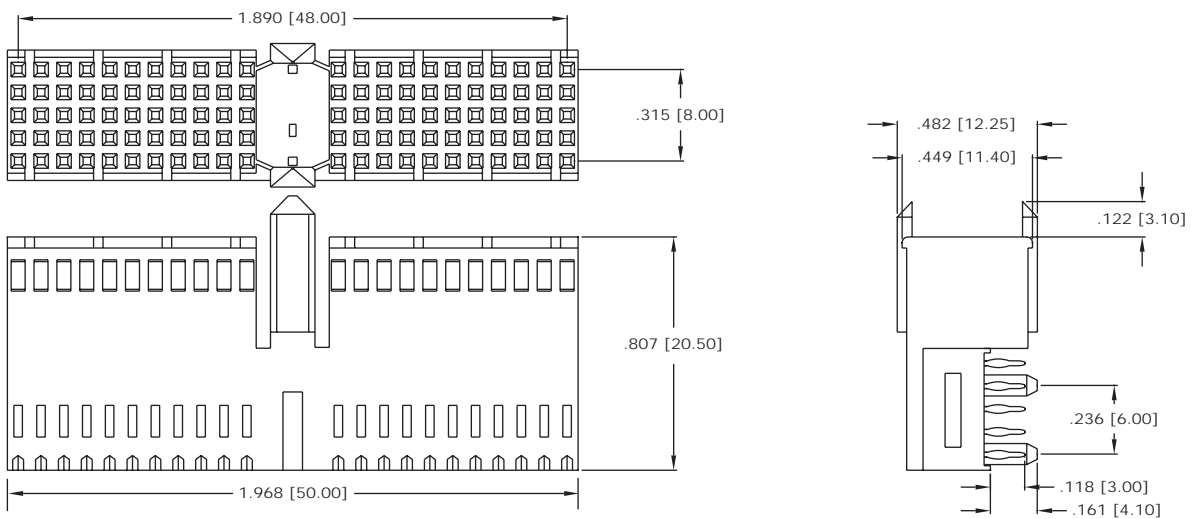

## 2CP - SR - C - 55

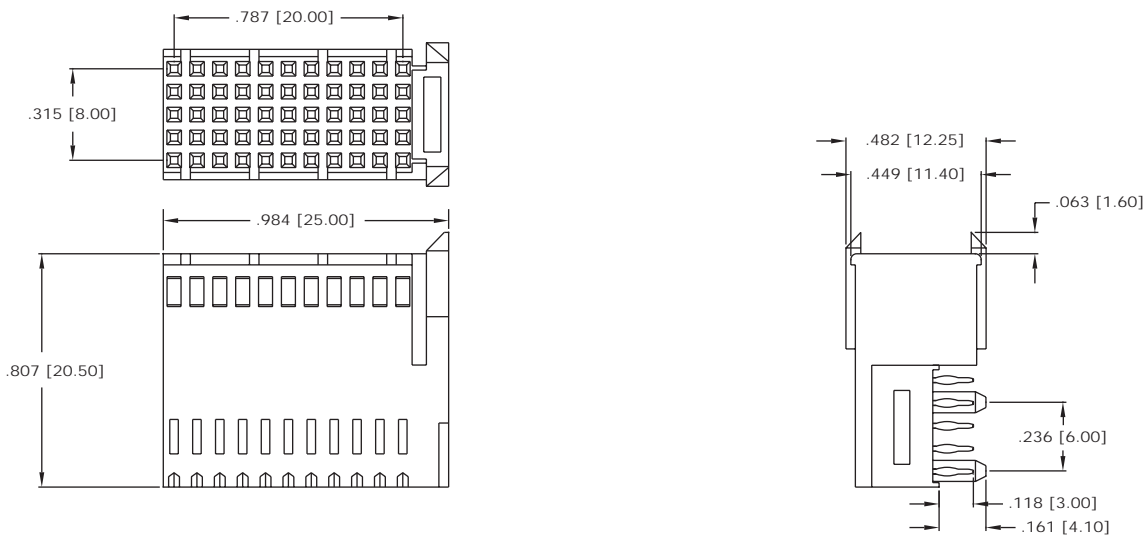

# COMPACT PCI

2.00mm CENTERLINE



## 2CP - SR - AB19 - 95

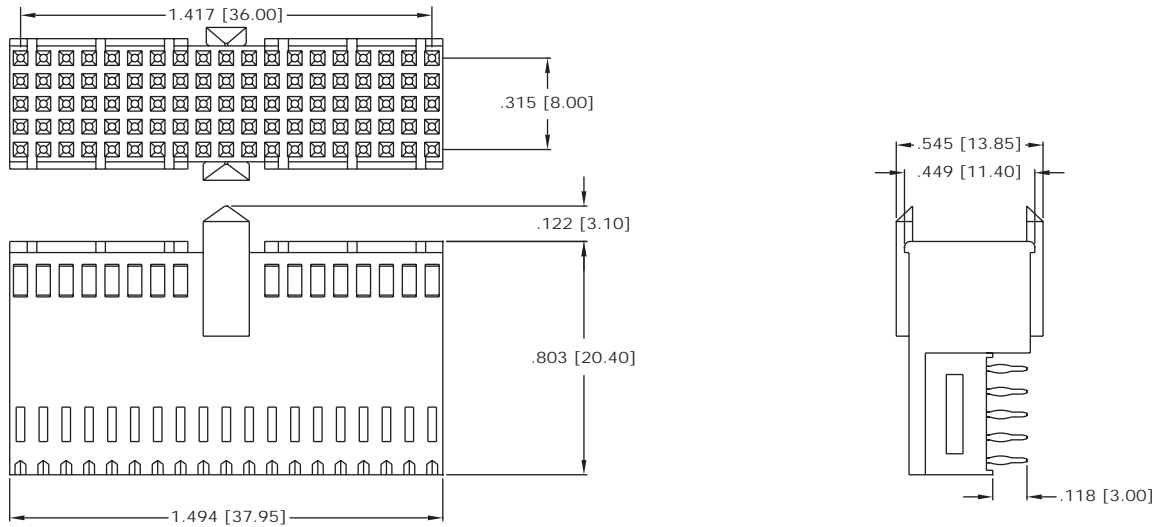

## 2CP - SR - AB22 - 110

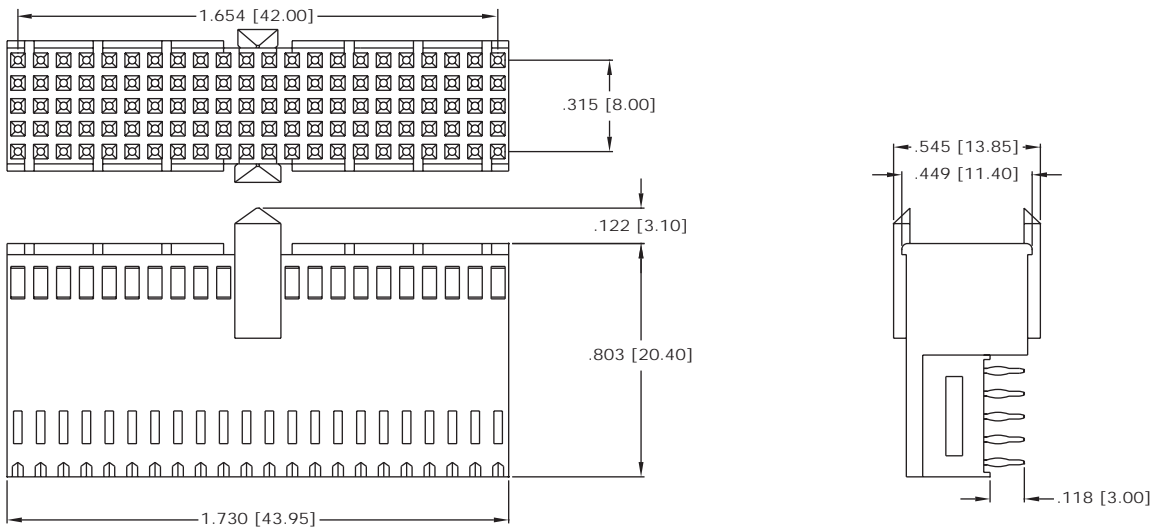

## 2CP - SR - AB25 - 125

