



D-SUB, HIGH DENSITY, STRAIGHT PCB MOUNT

STANDARD AND HIGH PROFILE

CENTURY INTERCONNECT PRODUCTS

Distributed by Electro-Stock, Inc. sales@electrostock.com
630-682-1542 Fax 630-682-1562 http://www.electrostock.com

ORDERING INFORMATION

C5D 15 S A
1 2 3 4 5

1... Series

C5D... High density straight PCB mount D-sub connector

C5DH... High density, high profile straight PCB mount D-sub connector with machined contacts

2... Number of Contacts

15, 26, 44, 62

3... Contact Type

P... Plug
S... Socket

4... Mounting Options

See page A-36

5... Plating Options

Blank... selective gold flash
15... 15μ" selective gold
30... 30μ" selective gold

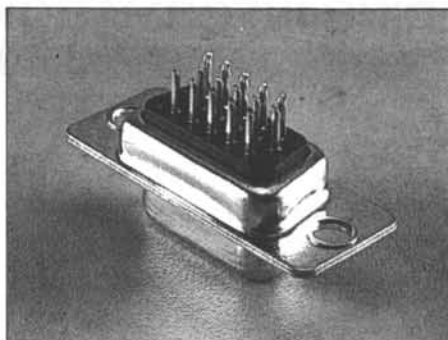

SHELL SIZE	No. of Contact Positions	A ±0.010 ±0.25	B ±0.005 ±0.13	C ±0.015 ±0.38	D ±0.010 ±0.25	E ±0.010 ±0.25	F ±0.005 ±0.13
E	15	<u>0.643</u> 16.33	<u>0.984</u> 24.99	<u>1.213</u> 30.81	<u>0.759</u> 19.28	<u>0.277</u> 7.04	<u>0.090</u> 2.29
A	26	<u>0.971</u> 24.66	<u>1.312</u> 33.32	<u>1.541</u> 39.14	<u>1.083</u> 27.51	<u>0.271</u> 6.88	<u>0.090</u> 2.29
B	44	<u>1.511</u> 38.38	<u>1.852</u> 47.04	<u>2.088</u> 53.04	<u>1.625</u> 41.28	<u>0.271</u> 6.88	<u>0.090</u> 2.29
C	62	<u>2.159</u> 54.84	<u>2.500</u> 63.50	<u>2.729</u> 69.32	<u>2.272</u> 57.71	<u>0.275</u> 6.99	<u>0.095</u> 2.41

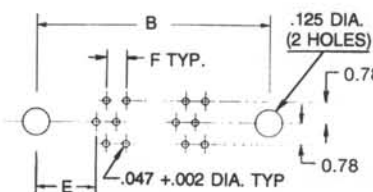
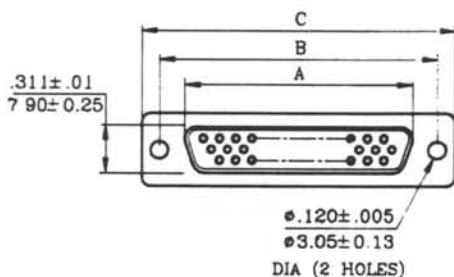

PCB LAYOUT
15 POSITIONS

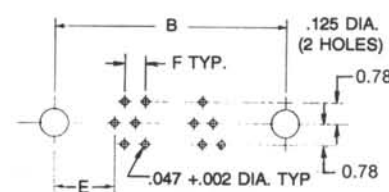

PCB LAYOUT
26, 44, 62 POSITIONS

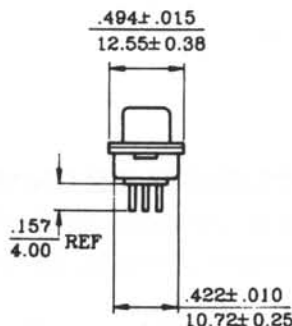
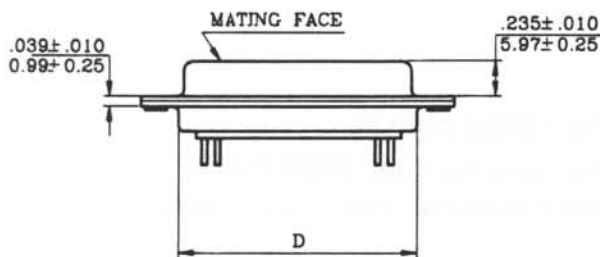

STANDARD PROFILE

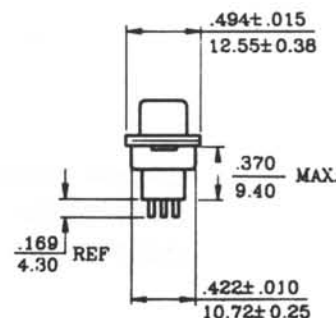

HIGH PROFILE

SEE PAGE A-1 FOR D-SUBMINIATURE SPECIFICATIONS